

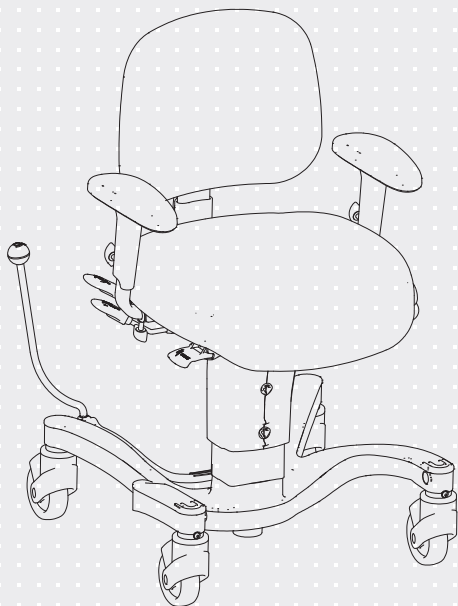

VELA Tango

VERSION: 700 & 700E

Manual no. 105675



VELA Tango 700

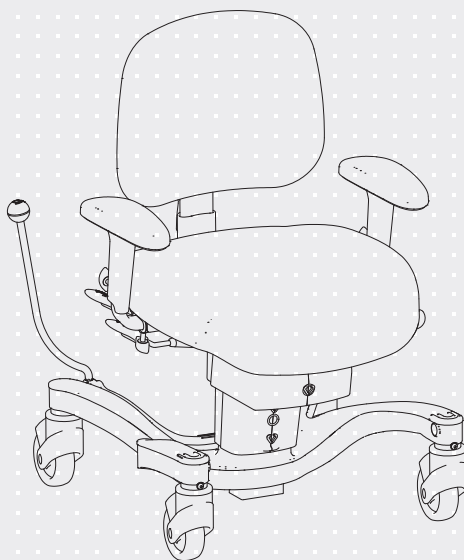

VELA Tango 700E

Guide:
How to adjust your chair.

vl1935.dk/T700-guide-E



TABLE OF CONTENTS

1.0. INTRODUCTION	3
1.1. WARNINGS	4
1.2. TROUBLESHOOTING	5
1.3. VELA TANGO WITH ELECTRIC HEIGHT ADJUSTMENT	6
1.3.1. Power input	6
1.3.2. Emission	6
1.3.3. Surge protection	6
1.4. LABELS USED ON THE CHAIR	7
1.5. SAFETY	7
1.5.1. Application	7
1.5.2. Transport	8
1.6. WARRANTY	8
1.7. UNPACKING THE CHAIR	8
1.8. MAINTENANCE	8
1.8.1. Wheels	8
1.8.2. Frame	9
1.8.3. Padding	9
1.8.4. Recycling guide	9
1.9. RECYCLING AND DISPOSAL	9
2.0. SETTINGS	10
2.0.1. Attaching the backrest	10
2.0.2. Height adjustment (Electric)	10
2.0.3. Height adjustment (Manual)	10
2.0.4. Setting angle of seat	11
2.0.5. Setting angle of backrest	11
2.0.6. Adjusting lumbar support*	11
2.0.7. Setting the back height	11
2.0.8. Back bolt (High back)*	12
2.0.9. Adjusting the armrest height	12
2.0.10. Adjusting the armrest width	12
2.0.11. Fold-down armrest*	12
2.0.12. Rotation	13
2.0.13. Brake	13
2.0.14. Foot pedal for braking	13
2.0.15. Folding footrest*	13
2.0.16. Changing the seat	14
2.0.17. Strolling bracket*	14
2.0.18. Charging (EI)	14
2.0.19. Angle switch (EI)*	14
2.0.20. Hand box (EI)*	15
2.0.21. Electric brake (EI)*	15
2.0.22. Setting the angle of the brake	15
2.0.23. Side-mounted swivel footrest*	15
2.0.24. 4-wheel brake*	16
2.0.25. Accessories	16

1.0. INTRODUCTION

DEAR CUSTOMER

Congratulations on your new VELA chair! We are sure this chair will give you daily pleasure. This user manual provides useful information on adjusting, operating and maintaining your chair.

Important

Please read this user manual carefully and keep it safe for when you need to refer to it. This manual is also available on VELA's website: www.vela.eu, where you can also find other relevant information.

If you have questions, experience errors or adverse events, please contact your VELA supplier.

We reserve the right to make changes.

VELA

Gøteborgevej 8-12
9200 Aalborg SV
Denmark
www.vela.eu

1.1. WARNINGS



Use	In case of an allergic reaction, stop using the chair and consult a doctor
Use	Only use original spare parts from VELA
Use	Only use the supplied charger for charging the chair
Use	Do not make any changes to the accessories that come with the chair
Use	Only use the chair for the intended purpose
Use	Only adjust the seat angle and backrest angle while the user is sitting in the chair and the user's feet are flat on the floor
Use	Always have the chair brake on when you sit down or get up
Use	The brake rod may only be used to operate the brake. If putting too much load on the brake rod, the brake rod/holder may brake and thereby lose its function
Use	Never use the chair on surfaces with level differences as the chair may become unstable
Use	Maintenance other than cleaning should always be performed by a professional
Use	Never service the chair while it is in use
Use	Always follow the recommended maintenance and cleaning instructions
Use	The chair's functions are intended for the user. Only the user or trained professionals should adjust the chair while the user is sitting in it
Use	Never use the electric height adjustment for more than two minutes at a time
Use	In the event of an electrical error or unintentional height adjustment, push both of the buttons for height adjustment simultaneously for 10 seconds
Use	Risk of shearing or squeezing fingers in moving parts. Therefore, never use the chair if someone is touching underneath the seat
Choking hazard	Choking hazard on small parts. Never allow children to play with the chair, as small parts are removable
Choking hazard	If the chair is equipped with electric height adjustment, cables will be present. Never let children play with these
Electric noise	Using cables other than the standard ones may increase electrical emission or decrease electrical immunity
Electric noise	Avoid placing the chair close to appliances that emit electrical noise
Electric noise	The chair may only be used with accessories mentioned in this user manual, as electromagnetic interference may otherwise occur
Electric noise	If the chair moves unintentionally or does not work as expected, find another location for the chair

1.2. TROUBLESHOOTING

Mistake	Possible cause and solution
Electric height adjustment does not work	The plug is not in the armrest – plug it in There is no power on the chair's battery. Charge the battery with the supplied charger The fuse is broken. See section 1.3.3
Manual height adjustment does not work	There is too much load or uneven load on the chair. Try to adjust the height without sitting in the chair. If this does not work, the gas cartridge is defective and should be replaced. Contact your VELA supplier
The brake function does not work	The brake is not activated. See section 2.0.13, 2.0.18, or 2.0.21
The armrest seems loose	One of the hand screws might be loose. Tighten the hand screw
The chair rolls badly	Wheels are blocked. Clean the wheels for wire residue and the like.
Brake rod or chassis is in the way when I move in the chair	You have a chair with seat rotation. Use seat rotation to straighten the chair. See section 2.0.12
Brake rod seems loose	The hand screw holding the brake rod might be loose. Tighten the screw. See section 2.0.22.

If the above does not solve your problem, you should contact your VELA supplier.

1.3. VELA TANGO WITH ELECTRIC HEIGHT ADJUSTMENT

1.3.1. POWER INPUT

Voltage: 24Vdc

Current: 0.5A

Power: 12VA

1.3.2. EMISSION

A VELA chair with electrical functions has been tested and complies with current requirements regarding electromagnetic radiation (EMC requirements). The chair is tested to the following specifications:

:: Emission class CISPR 11, Group 1, Class B

See more details at www.vela.eu

1.3.3. SURGE PROTECTION

A fuse is installed on the chair which secures the chair against power surges. The replaceable part of the fuse has the following specifications:

:: Flat fuse, type: ATOF blade fuse, fast-acting

:: Voltage: 32V



:: Current: 10A

:: Max. current: 1000A

Replacement of the fuse may only be performed by professionals, as the cause of the breach must be documented for safety reasons.

IN GENERAL

1.4. LABELS USED ON THE CHAIR

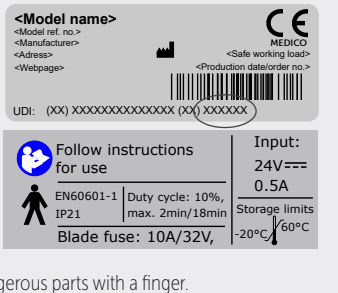
Warning	Risk of shear and squeeze: Keep hands and fingers away from moving parts	
Icon	Read "Instruction For Use" before use	
Icon	Part used: Type B cf. IEC60601-1 covering the following areas of the chair:	
Labels	60 x 22.5 mm The last six digits are the product ID number: This label only applies to chairs with electrical functions: The chair is IP21 approved, which corresponds to protection against water droplets as well as against touching dangerous parts with a finger.	 <p><Model name> <Model ref. no.> <Manufacturer> <Address> <Webpage></p> <p>CE MEDICO <Safe working load> <Production date/order no.></p> <p>UDI: (xx) xxxxxxxxxxxxxxxxx (xx) xxxxxxx</p> <p>Follow instructions for use</p> <p>EN60601-1 IP21 Duty cycle: 10%, max. 2min/18min Blade fuse: 10A/32V</p> <p>Input: 24V 0.5A Storage limits: -20°C / 60°C</p>

Labels on the chair should be read at a distance of approx. 40 cm under normal daylight conditions.

For labels related to the operation of the chair, please refer to section 2.0.

1.5. SAFETY

This chair is CE marked and complies with applicable EU regulations. The chair is manufactured by: VELA, Gøteborgvej 8-12, 9200 Aalborg SV, Denmark.

The VELA Tango with electrical functions meets all safety requirements according to IEC 60601-1, including requirements for EMC according to IEC60601-1-2.

1.5.1. APPLICATION

This chair is an indoor chair intended for sitting and private use.

- :: The chair is not built to stand on
- :: The wheel brake must always be activated when sitting down or standing up

All variants of this chair are tested and approved for a maximum load of 160 kg.

Note: Persons using a harness in the chair must always be supervised when the harness is in use.

1.5.2. TRANSPORT

When transporting the chair by car, airplane or any other means of transport, always use the chair brake. The chair is not approved for use as a passenger seat in any means of transportation and may not be used as such.

The chair is designed to be transported under the following environmental conditions:

Temperature: - 20°C to + 60°C
Humidity: 15-95%

Allow the chair to stand for 24 hours before use if it has been stored below - 10°C.

1.6. WARRANTY

VELA grants a right of claim under applicable law in the country where the chair is acquired. The right of complaint applies only when using original spare parts and accessories, as well as customisations made by professionals.

Note: if an exclusive contractual agreement has been made directly with VELA, this applies!

VELA assumes no liability for damages to the product or the user caused by:

:: Transportation

:: Misuse

:: Normal wear and tear

:: Wrong use

:: Use of spare parts and accessories that are not original VELA products

:: Adjustments made by unauthorised service technicians

1.7. UNPACKING THE CHAIR

The chair comes in environmentally friendly and recyclable packaging.

In case of defects or transport damage to the chair, please contact your VELA supplier right away. In such cases, do not attempt to use the chair or to fix it yourself.

On delivery you have received:

:: VELA chair

:: Instructions for use

:: Charger (only for chairs with electrical functions)

Note: see item 2.0.1 for correct attachment of backrest.

1.8. MAINTENANCE

We recommend an annual inspection of the chair to identify any defective or worn parts. All removable parts should be tightened regularly. You can find various guides on www.vela.eu.

1.8.1. WHEELS

We recommended you regularly check the wheels and remove any residual threads, etc.

1.8.2. FRAME

Clean with lukewarm water and if necessary, add some pH-neutral detergent.

1.8.3. PADDING

Fabric: Clean by chemical cleaning, with furniture cleaner or with water using a hard-wrung cloth.

Synthetic fabric or leather: Clean with water or mild soap using a hard-wrung cloth.

Leather: Clean by vacuuming with a soft brush. Avoid using detergent.

Note: On www.vela.dk you can find cleaning instructions for all our standard upholstery types.

1.8.4. RECYCLING GUIDE

Your VELA chair can be reused by another person when you no longer need it as long as the chair is serviced by a technician beforehand.

The life expectancy of the chair is five years for regular and proper use as long as VELA, your VELA supplier or a trained professional perform an annual inspection with replacement of worn parts.

1.9. RECYCLING AND DISPOSAL

This product contains recyclable materials. Therefore, the product must be disposed of in accordance with local regulations and not together with ordinary household waste. Proper disposal and recycling

will help prevent negative effects on the environment and people.

Note: Electrical and electronic equipment and accompanying batteries contain materials, components and substances that can be harmful to human health and the environment if the waste is not handled properly.

Electrical and electronic equipment and batteries are marked with the icon shown below. This symbolises that electrical and electronic equipment and batteries must not be disposed of together with unsorted household waste but must be collected separately.



It is important that you return your used batteries to the established schemes. In this way, you help ensure that batteries are recycled in accordance with current legislation and do not cause unnecessary harm to the environment.

2.0. SETTINGS

The gas spring and the electric lifting mechanism should only be replaced by a VELA technician or a person trained in this field.



2.0.1. ATTACHING THE BACKREST

The backrest is lowered into the hole. Screw the handle back on and tighten securely.



2.0.2. HEIGHT ADJUSTMENT (ELECTRIC)

Can be operated from the underside of either the right or left armrest. The armrest can easily be moved to the opposite side. VELA Tango EL is also available with height adjustment via hand box (if caregivers are to be able to adjust the height).

Note: Height function should only be used continuously for one minute, then a nine-minute break should follow.



2.0.3. HEIGHT ADJUSTMENT (MANUAL)

Adjusted by pulling up the front handle on the right-hand side.

Note: Setting the angle of backrest and seat should always be done with your feet flat on the floor.

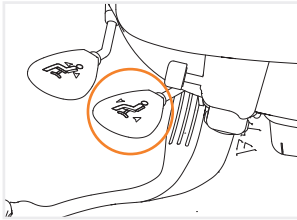

2.0.4. SETTING ANGLE OF SEAT

Adjusted by pulling up the middle handle on the right-hand side.

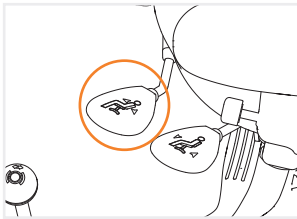

2.0.5. SETTING ANGLE OF BACKREST

Adjusted by pulling up the rear handle on the right-hand side. Only operate the handle when someone is sitting in the chair - as the backrest tilts forward.

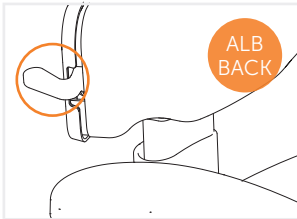

2.0.6. ADJUSTING LUMBAR SUPPORT*

The backrest can be adjusted to provide optimal lumbar support by pulling up the handle on the right-hand side of the backrest. The backrest adjusts to fit and support the lower back. Release the handle, and the backrest remains in the desired lumbar angle.

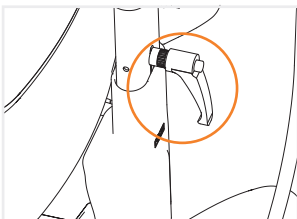

2.0.7. SETTING THE BACK HEIGHT

Release the handle located on the back. Adjust the back. Remember to tighten the handle afterwards.

* Depending on model

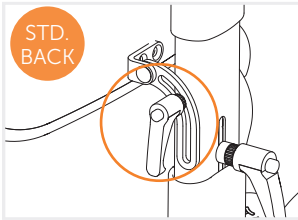

2.0.8. BACK BOLT (HIGH BACK)*

The backrest can be set to a specific angle by adjusting and attaching the bolt mounted on the back of the backrest.

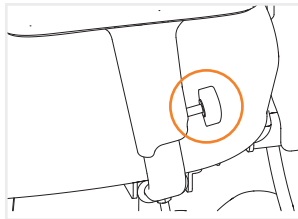

2.0.9. ADJUSTING THE ARMREST HEIGHT

Adjusted by loosening the screw on the armrest bar and adjusting the height of the armrest. Remember to tighten the screw when done.

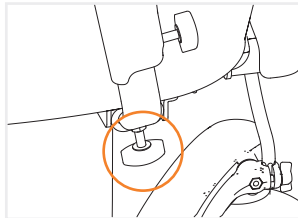

2.0.10. ADJUSTING THE ARMREST WIDTH

Adjusted by loosening the screw under the seat on the seat support and adjusting the armrest width by pulling out the armrest. Remember to tighten the screw when done.

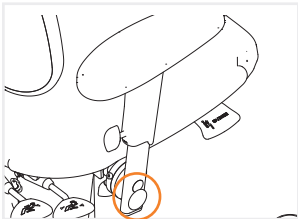

2.0.11. FOLD-DOWN ARMREST*

To fold down the armrest, press the button on the side of the armrest and push the armrest backwards and down.

Note: The armrest is only locked when it is in an upright position. The armrest can only be folded down if the width adjustment of the armrest allows it.

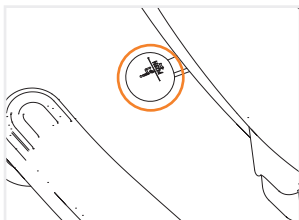

2.0.12. ROTATION

The seat is rotated by pushing back on the front handle on the left-hand side. Rotation can be turned and locked in the following positions: 90° to the left, 0° (neutral), and 90° to the right.

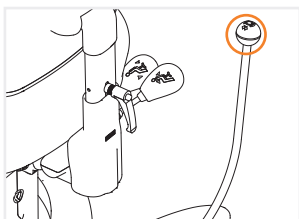

2.0.13. BRAKE

The brake is activated by moving the handle on the side of the chair forward. Unlock the chair by moving the handle back into the upright position.

Note: See Setting the angle of the brake, section 2.0.22. for adjusting the position of the brake and the distance to the seat.

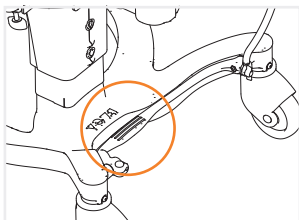

2.0.14. FOOT PEDAL FOR BRAKING

The brake can be activated with the foot pedal by pressing the foot against the brake shaft in the area shown.

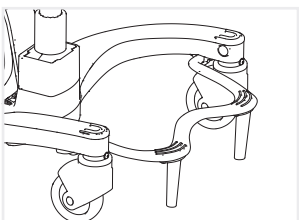

2.0.15. FOLDING FOOTREST*

Stabilising foot support that can also be used as a footboard when moving in and out of the chair.

* Depending on model

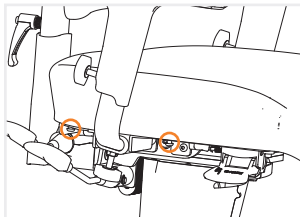

2.0.16. CHANGING THE SEAT

The seat can be replaced by removing the four thumbscrews that are located in each corner under the seat.

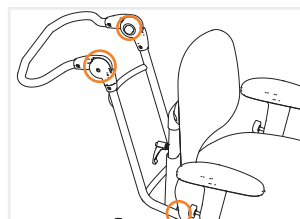

2.0.17. STROLLING BRACKET*

Strolling bracket for transporting a person in the chair. The strolling bracket is mounted to fittings under the seat using two finger screws. This is also where the depth is adjusted. The height is adjusted by pressing the two buttons on the side of the bracket while the handle is positioned at the desired height.

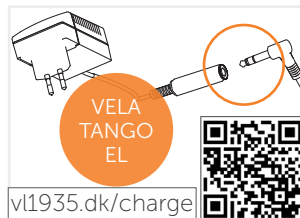

2.0.18. CHARGING (EL)

Daily charging is recommended. Remove the operation plug from the back of the armrest and place it in the charger as shown. The charger is plugged into an electrical outlet. When the chair is charging, the LED on the charger is yellow. When the chair is fully charged, the LED turns green.

Note: The chair should not be used during charging.



2.0.19. SOFT TOUCH CONTACT(EL)*

Placed on the underside of the left or right-hand armrest as required. Remember, position the switch correctly (see section 2.0.2.).



2.0.20. HAND BOX (EL)*

The hand box is used via push buttons on the front. VELA hand boxes can have one or more functions. The icons on the hand box show the button functions.

Note: Insert plug in hand box to operate functions.

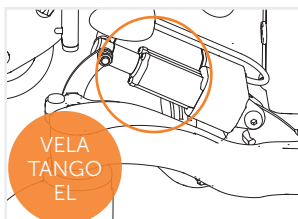

2.0.21. ELECTRIC BRAKE (EL)*

The electric brake is activated and deactivated using the hand box or switches. It is advisable to activate or deactivate the brake completely when using this feature. Can also be used together with the 4-wheel brake (see section 2.0.24.)

Note: The brake can only be used via switches under the armrest, the hand box, or angle switch.

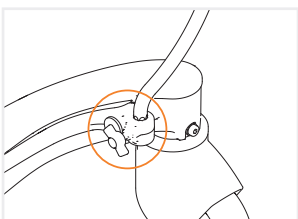

2.0.22. SETTING THE ANGLE OF THE BRAKE

Loosen the thumbscrew and remove the brake rod from the holder. Insert the brake rod in the desired side and angle. Remember to retighten the thumbscrew.

Note: The brake can be set at 30° intervals. The brake rod can be moved forwards/backwards and closer to/further from the seat as required. The brake can also be moved to the opposite side.

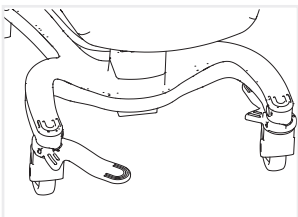

2.0.23. SIDE-MOUNTED SWIVEL FOOTREST*

Mounted on the underside of the front right and/or left chair legs, the footrest can be turned in/out and provide support for a leg as needed. Once the footrest is inside, it is tucked away under the chair frame. The footrest has a rotation stop in both the inner and outer positions.

* Depending on model

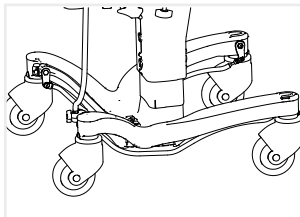

2.0.24. 4-WHEEL BRAKE*

Is activated via the hand/foot brake on all chairs except on chairs with electric brake, where it is activated via hand box or switches. 4-wheel brake brakes on all wheels and provides a stable seat on uneven/skewed surfaces.

Note: On the electric version it is advisable to activate or deactivate the brake completely when using this feature.

2.0.25. ACCESSORIES

This chair is available with a wide range of accessories. See a complete list of accessories at: www.vela.eu

Note: Charger is included as an accessory when purchasing a VELA chair with electrical functions.

* *Depending on model*