

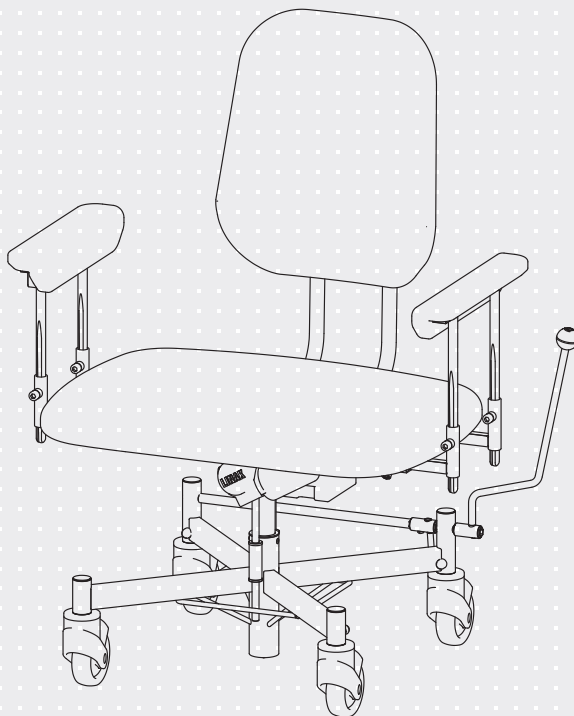

VELA Tango

MODEL: 300, 300E & 310E

Manual no. 105479



ISO 9001
ISO 14001

The chair's design varies depending on the model

TABLE OF CONTENTS

1.0. INTRODUCTION	3
1.1. WARNINGS	4
1.2. TROUBLESHOOTING	5
1.3. VELA TANGO WITH ELECTRIC HEIGHT ADJUSTMENT	6
1.3.1. Power input	6
1.3.2. Emission	6
1.4. LABELS USED ON THE CHAIR	6
1.5. SAFETY	7
1.5.1. Intended use	7
1.5.2. Transport	7
1.6. WARRANTY	8
1.7. UNPACKING THE CHAIR	8
1.8. MAINTENANCE	8
1.8.1. Wheels	8
1.8.2. Frame	8
1.8.3. Padding	8
1.8.4. Recycling guide	9
1.9. RECYCLING AND DISPOSAL	9
2.0. USER MANUAL	10
2.0.1. Height adjustment (EI)*	10
2.0.2. Height adjustment (Manual)*	10
2.0.3. Handheld control (EI)*	10
2.0.4. Adjustment of seat depth	10
2.0.5. Adjusting the backrest angle	11
2.0.6. Setting the back height	11
2.0.7. Adjusting the armrest height	11
2.0.8. Adjusting the armrest width	11
2.0.9. Brake*	12
2.0.10. Charging (EI)*	12
2.0.11. Strolling bracket*	12
2.0.12. Electric brake (EI)*	12
2.0.13. 4-wheel brake*	13
2.0.14. Accessories	13

1.0. INTRODUCTION

DEAR CUSTOMER

Congratulations on your new VELA chair! We are sure this chair will give you daily pleasure. This user manual provides useful information on adjusting, operating and maintaining your chair.

Important

Please read this user manual carefully and keep it safe for when you need to refer to it. This manual is also available on VELA's website: www.vela.eu, where you can also find other relevant information.

If you have questions, experience errors or adverse events, please contact your VELA supplier.

We reserve the right to make changes.

VELA

Gøteborgvej 8-12
DK-9200 Aalborg SV
Denmark
www.vela.eu

1.1. WARNINGS



Use	In case of an allergic reaction, stop using the chair and consult a doctor
Use	Only use original spare parts from VELA
Use	Only use the supplied charger for charging the chair
Use	Do not make any changes to the accessories that come with the chair
Use	Only use the chair for the intended purpose
Use	Always have the chair brake on when you sit down or get up
Use	Never use the chair on surfaces with level differences as the chair may become unstable
Use	Maintenance other than cleaning should always be performed by a professional
Use	Never service the chair while it is in use
Use	Always follow the recommended maintenance and cleaning instructions
Use	The chair's functions are intended for the user. Only the user or trained professionals should adjust the chair while the user is sitting in it
Use	Never use the electric height adjustment for more than two minutes at a time
Use	In the event of an electrical error or unintentional height adjustment, push both of the buttons for height adjustment simultaneously for 10 seconds
Use	Risk of shearing or squeezing fingers in moving parts. Therefore, never use the chair if someone is touching underneath the seat
Choking hazard	Choking hazard on small parts. Never allow children to play with the chair, as small parts are removable
Choking hazard	If the chair is equipped with electric height adjustment, cables will be present. Never let children play with these
Electric noise	Using cables other than the standard ones may increase electrical emission or de-crease electrical immunity
Electric noise	Avoid placing the chair close to appliances that emit electrical noise
Electric noise	The chair may only be used with accessories mentioned in this user manual, as elec-tro-magnetic interference may otherwise occur
Electric noise	If the chair moves unintentionally or does not work as expected, find another location for the chair

1.2. TROUBLESHOOTING

Mistake	Possible cause and solution
Electric height adjustment does not work	There is no power on the chair's battery. Charge the battery with the supplied charger
Manual height adjustment does not work	There is too much load or uneven load on the chair. Try to adjust the height without sitting in the chair. If this does not work, the gas cartridge is defective and should be replaced. Contact your VELA supplier
The brake function does not work	The brake is not activated. See section 2.0.9.
The armrest seems loose	One of the hand screws might be loose. Tighten the hand screw
The chair rolls badly	Wheels are blocked. Clean the wheels for wire residue and the like.

If the above does not solve your problem, you should contact your VELA supplier.

1.3. VELA TANGO WITH ELECTRIC HEIGHT ADJUSTMENT

1.3.1. POWER INPUT

Voltage: 24Vdc
 Current: 0.5A
 Power: 12VA



1.3.2. EMISSION

A VELA chair with electrical functions has been tested and complies with current requirements regarding electromagnetic radiation (EMC requirements). The chair is tested to the following specifications:

:: Emission class CISPR 11, Group 1, Class B

See more details at www.vela.eu

1.4. LABELS USED ON THE CHAIR

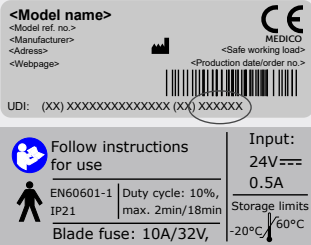
Warning	Risk of shear and squeeze: Keep hands and fingers away from moving parts	
Icon	Read "Instruction For Use" before use	
Icon	Part used: Type B cf. IEC60601-1 covering the following areas of the chair:	
Labels	60 x 22,5 mm The last six digits are the product ID number: This label only applies to chairs with electrical functions: The chair is IP21 approved, which corresponds to protection against water droplets, as well as against touching dangerous parts with a finger.	 <p> <Model name> <Model ref. no.> <Manufacturer> <Address> <Webpage> UDI: (XX)XXXXXXXXXXXXXXXX (XX)XXXXXX </p> <p> Follow instructions for use EN60601-1 IP21 Duty cycle: 10%, max. 2min/18min Blade fuse: 10A/32V, </p> <p> Input: 24V 0.5A Storage limits: -20°C / 60°C </p>

Labels on the chair should be read at a distance of approx. 40 cm under normal daylight conditions.

6 For labels related to the operation of the chair, please refer to section 2.0.

IN GENERAL

1.5. SAFETY

This chair is CE marked and complies with applicable EU regulations. The chair is manufactured by: VELA, Gøteborgvej 8-12, 9200 Aalborg SV, Denmark.

The VELA Tango 300/310 with electrical functions meets all safety requirements according to IEC 60601-1, including requirements for EMC according to IEC60601-1-2.

1.5.1. INTENDED USE

This device is intended to support a bariatric user in a sitting posture while performing indoor activities of daily living, including work activities.

- :: The chair is not built to stand on
- :: The wheel brake must always be activated when sitting down or standing up

All variants of VELA Tango 310 are tested and approved for a maximum load of 200 kg. For optimal use, the chair's recommended user weight is 130-160 kg.

All variants of VELA Tango 300E are tested and approved for a maximum load of 200 kg. For optimal use, the chair's recommended user weight is 130-175 kg.

All variants of VELA Tango 310E are tested and approved for a maximum load of 300 kg. For optimal use, the chair's recommended user weight is 130-250 kg.

1.5.2. TRANSPORT

When transporting the chair by car, airplane or any other means of transport, always use the chair brake. The chair is not approved for use as a passenger seat in any means of transportation and may not be used as such.

The chair is designed to be transported under the following environmental conditions:

Temperature: - 20°C to + 60°C
Humidity: 15-95%

Allow the chair to stand for 24 hours before use if it has been stored below - 10°C.

1.6. WARRANTY

VELA grants a right of claim under applicable law in the country where the chair is acquired. The right of complaint applies only when using original spare parts and accessories, as well as customisations made by professionals.

Note: if an exclusive contractual agreement has been made directly with VELA, this applies!

VELA assumes no liability for damages to the product or the user caused by:

- :: Transportation
- :: Misuse
- :: Normal wear and tear
- :: Wrong use
- :: Use of spare parts and accessories that are not original VELA products
- :: Adjustments made by unauthorised service technicians

1.7. UNPACKING THE CHAIR

The chair comes in environmentally friendly and recyclable packaging.

In case of defects or transport damage to the chair, please contact your VELA supplier right away. In such cases, do not attempt to use the chair or to fix it yourself.

On delivery you have received:

- :: VELA Chair
- :: Instructions for use
- :: Charger (only for chairs with electrical functions)

1.8. MAINTENANCE

We recommend an annual inspection of the chair to identify any defective or worn parts. All removable parts should be tightened regularly. You can find various guides on www.vela.eu.

1.8.1. WHEELS

We recommended you regularly check the wheels and remove any residual threads, etc.

1.8.2. FRAME

Clean with lukewarm water and if necessary, add some pH-neutral detergent.

1.8.3. PADDING

Fabric: Clean by chemical cleaning, with furniture cleaner or with water using a hard-wrung cloth.

Synthetic fabric or leather: Clean with water or mild soap using a hard-wrung cloth.

Leather: Clean by vacuuming with a soft brush. Avoid using detergent.

Note: On www.vela.eu you can find cleaning instructions for all our standard upholstery types.

1.8.4. RECYCLING GUIDE

Your VELA chair can be reused by another person when you no longer need it as long as the chair is serviced by a technician beforehand.

The life expectancy of the chair is five years for regular and proper use as long as VELA, your VELA supplier or a trained professional perform an annual inspection with replacement of worn parts.

1.9. RECYCLING AND DISPOSAL

This product contains recyclable materials. Therefore, the product must be disposed of in accordance with local regulations and not together with ordinary household waste. Proper disposal and recycling will help prevent negative effects on the environment and people.

Note: Electrical and electronic equipment and accompanying batteries contain materials, components and substances that can be harmful to human health and the environment if the waste is not handled properly.

Electrical and electronic equipment and batteries are marked with the icon shown below. This symbolises that electrical and electronic equipment and batteries must not be disposed of together with unsorted household waste but must be collected separately.



It is important that you return your used batteries to the established schemes. In this way, you help ensure that batteries are recycled in accordance with current legislation and do not cause unnecessary harm to the environment.

2.0. USER MANUAL

The gas spring and the electric lifting mechanism should only be replaced by a VELA technician or a person trained in this field.



2.0.1. HEIGHT ADJUSTMENT (EL)*

Can be operated by pressing on the switch that is located on the side of the right or left armrest.

Note: VELA Tango El is also available with height adjustment via handheld control (see item 2.0.3.).



2.0.2. HEIGHT ADJUSTMENT (MANUAL)*

Adjusted by pulling up the handle under the armrest on the right-hand side.

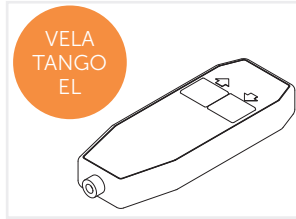

2.0.3. HANDHELD CONTROL (EL)*

The handheld control is used to adjust the height of the chair via push buttons on the front.

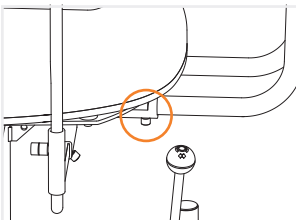

2.0.4. ADJUSTMENT OF SEAT DEPTH

The seat depth is adjusted by loosening the 2 Unbrako bolts under the seat (next to the backrest arm), after which you will be able to push the backrest back and forth. Remember to tighten the Unbrako bolts securely again after adjusting the seat depth.

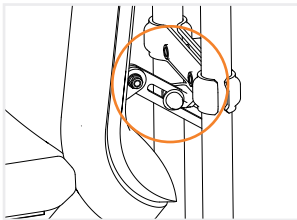

2.0.5. ADJUSTING THE BACKREST ANGLE

The backrest is angled by loosening the small screw on the back bolt, after which the backrest can be adjusted to the desired angle. Remember to tighten the bolt securely once the correct angle has been achieved.

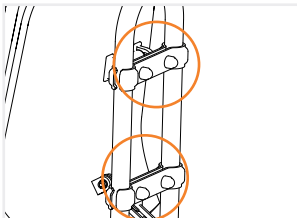

2.0.6. SETTING THE BACK HEIGHT

The back height is adjusted by loosening the 4 Unbrako bolts that are placed behind the backrest arm. Once they are loose, the height of the back can be adjusted. Remember to tighten the Unbrako bolts securely again.

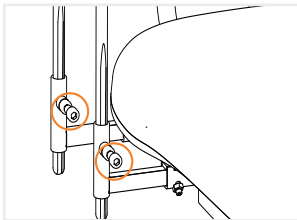

2.0.7. ADJUSTING THE ARMREST HEIGHT

Adjust by loosening both screws under the armrest bar and adjusting the height of the armrest. Remember to tighten the screws securely again.

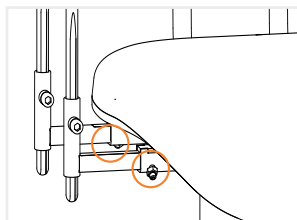

2.0.8. ADJUSTING THE ARMREST WIDTH

Adjust by loosening both screws under the seat. Remember to tighten the screws securely again.

Note: The armrests may only be adjusted up until the red 'stop' mark.

** Depending on model*

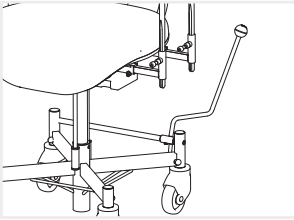

2.0.9. BRAKE*

The brake on the VELA Tango is activated by moving the handle on the side of the chair forward. Unlock the chair by moving the handle back into the upright position.

Note: Available with the brake mounted on the right or left side.

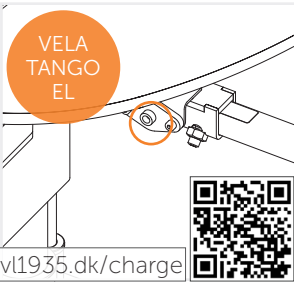

2.0.10. CHARGING (EL)*

Daily charging is recommended. The chair is charged by plugging the charger into the switch placed behind the chair under the seat on the right side. An LED will light yellow when the chair is charging and green when the chair is fully charged.

Note: The chair should not be used during charging.

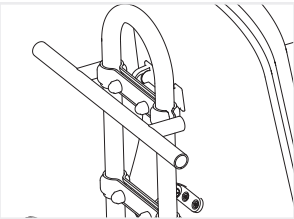

2.0.11. STROLLING BRACKET*

Strolling bracket for transporting a person in the chair. The strolling bracket is fitted to the top back clamp.

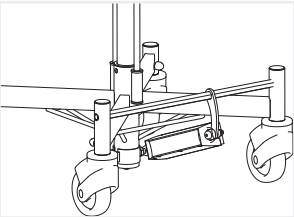

2.0.12. ELECTRIC BRAKE (EL)*

VELA Tango with electric brake, is operated via remote control. We advice to fully brake/unlock the brake every time.

Note: This function can only be controlled via remote control.

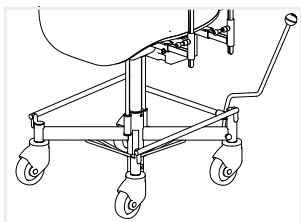

2.0.13. 4-WHEEL BRAKE*

Is activated via the hand/foot brake on all chairs except on chairs with electric brake, where it is activated via hand box or switches. 4-wheel brake brakes on all wheels and provides a stable seat on uneven/skewed surfaces.

Note: On the electric version it is advisable to activate or deactivate the brake completely when using this feature.

2.0.14. ACCESSORIES

This chair is available with a range of accessories. See a complete list of accessories at: www.vela.eu

Note: Charger is included as an accessory when purchasing a VELA chair with electrical functions.

* *Depending on model*

